

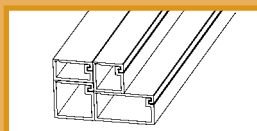

MINI
SYSTEM

Minicanali con coperchio integrato MA.
MA Minitrunkings with hinged cover.



pagina / page

2.2.4

Minicanali completi di coperchio.
Minitrunkings complete with cover.

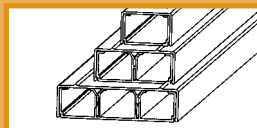

pagina / page

2.3.2

Dati tecnici.
Technical data.



pagina / page

2.3.12

MINISYSTEM. Elementi del sistema.

System components.





Type G
LINEADIN

TRS1440
TRS1460

TRS16

TRS15MN

TRS15MN

SCM090

MINI EV

VPG186S

MINI T

RMCP

VPG18S

VPG1812S

SCM090

MINI T

MINI EV

RMCP

RMCP

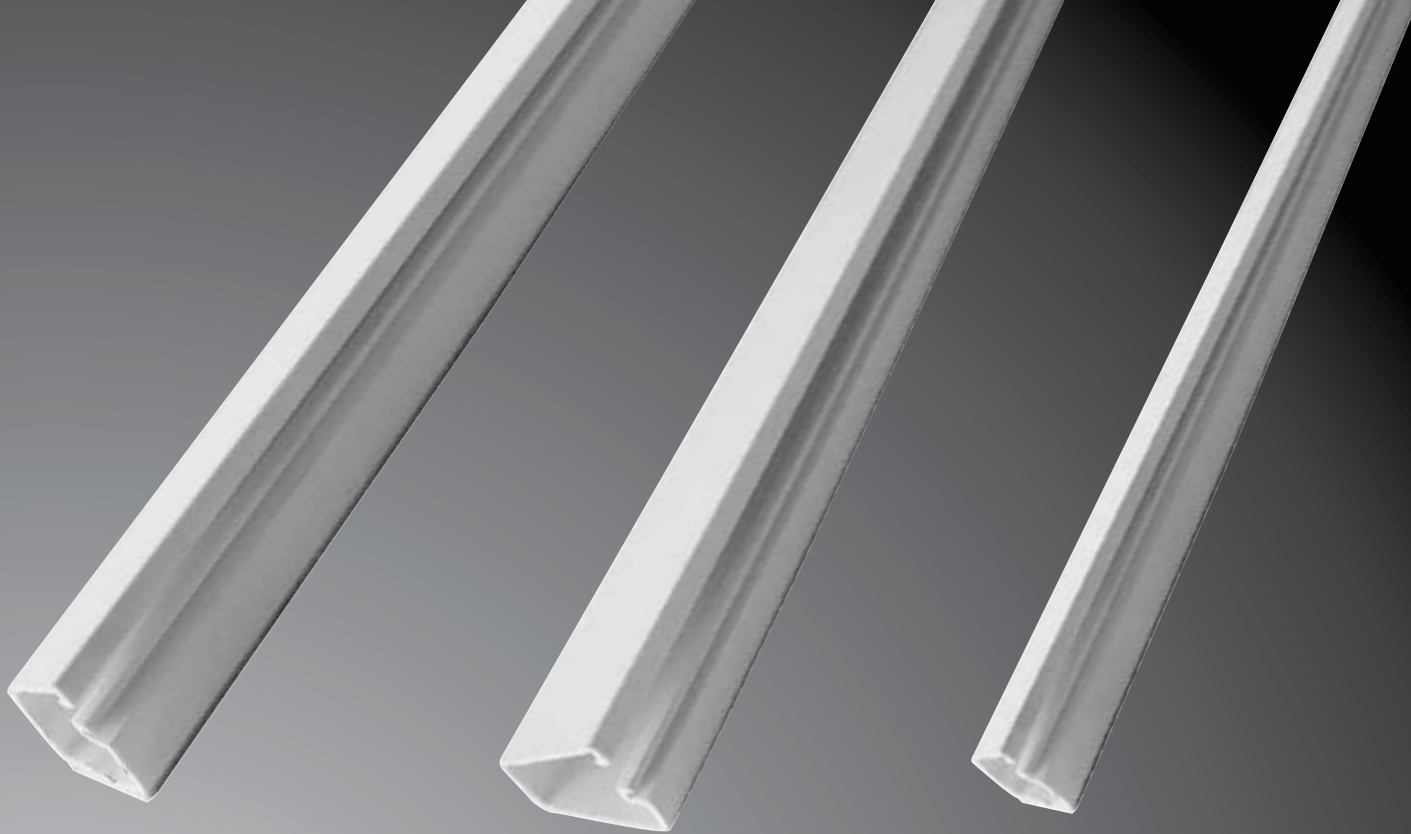

MINI
SYSTEM
MA

Minicanali con coperchio integrato e adesivo sul fondo.
PVC Rigido Autoestinguente Classe 1 (UL94-VO).

*Minitrunkings with hinged cover and adhesive base.
Self-extinguishing rigid PVC Class 1 (UL94-VO).*

Codifica per l'ordine dei canali
Functional part numbering system

MA117



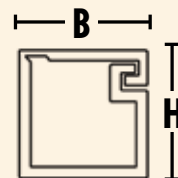

Tipo
Type



- I canali vengono forniti con coperchio integrato e adesivo sul fondo.
- All trunkings come complete with hinged cover and adhesive base.

COLORI
COLOURS  = Bianco / White Type 9010

Minicanali con coperchio integrato e adesivo sul fondo. PVC Rigido Autoestinguento Classe 1 (UL94-VO).
Minitrunkings with hinged cover and adhesive base. Self-extinguishing rigid PVC Class 1 (UL94-VO).

Tipo	Dimensioni BxH mm	Colore	Imballo m	S.G. mm ²	Lung. barre m	Cartone peso Kg
Part number	Duct Size BxH mm	Colour	Standard Carton m	G.S. mm ²	Length m	Carton Weight Kg
MA117	12,5x7,5		240	65	2	14,2
MA211	10x10		240	70	2	14,2
MA215	15x10		96	105	2	7,0
MA221	20x10		120	142	2	11,5
MA312	12,5x12,5		160	110	2	12,0



SC503

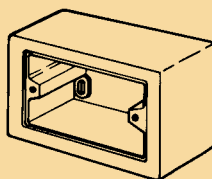

Scatola portautenze con interasse 83,5 (Mod. 503).
Pareti prefabbricate per l'ingresso dei minicanali.
Socket box for switches with centres of 83,5 (Mod.503). Prefracted walls for minitrunkings entry.
GWT= T850°

SCM090

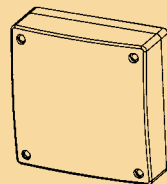

Scatola di derivazione per minicanali. Junction box for minitrunking.
min 20x10 - max 60x30

MA117	12,5x7,5
MA211	10x10
MA215	15x10
MA221	20x10
MA312	12,5x12,5

Tipo	Colore	Imballo pz.
Part number	Colour	Packing pcs.
SC503		9

Tipo	Colore	Imballo pz.
Part number	Colour	Packing pcs.
SCM090		10

MA117	12,5x7,5
MA211	10x10
MA215	15x10
MA221	20x10
MA312	12,5x12,5

n° conduttori / conductors mm ²					Ø max
1	1,5	2,5	4	6	cavo / cable
6	4	3	2	1	5
6	4	3	2	2	7
9	7	5	3	3	8
13	9	6	5	4	8
10	7	5	4	3	10



MINI
SYSTEM

Minicanali per installare, ampliare o modificare impianti elettrici dove lo spazio è limitato.
Materiale: PVC Rigido Autoestinguente Classe 1 (UL94-VO).
Lunghezza: 2 metri

*Minitrunkings for installation or modification of electrical systems where there is not enough room.
Self-extinguishing rigid PVC Class 1 (UL94-VO).
Length: 2 meters*



Codifica per l'ordine dei canali
Functional part numbering system

G41

BEU

Tipo
Type

Colore
Colour

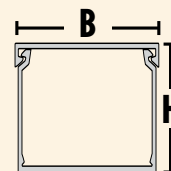

- I canali vengono forniti completi di coperchio.
- All trunkings come complete with cover.

COLORI
COLOURS BEU = Bianco / White Type 9010

Minicanali completi di coperchio. PVC Rigido Autoestinguente Classe 1 (UL94-VO).
Minitrunkings complete with cover. Self-extinguishing rigid PVC Class 1 (UL94-VO).

	Sezione fondo	Tipo	Dimensioni BxH mm	Colore	Imballo m	S.G. mm ²	Lung. barre m	Cartone peso Kg
	Section of the bottom	Part number	Duct Size BxH mm	Colour	Standard Carton m	G.S. mm ²	Length m	Carton Weight Kg
		G41	20x10	BEU	120	128	2	11
 coperchio avvolgente wrap-around cover		MS201	20x10	BEU	120	128	2	11,2
		MS301	30x10	BEU	90	208	2	12,8
		MS4010	40x10x2	BEU	68	250 (125x2)	2	14,5
 coperchio avvolgente wrap-around cover		BS11	16x16	BEU	96	180	2	12,6
		BS21	25x16	BEU	72	320	2	11,4
		BS31	40x16x2	BEU	54	430 (215x2)	2	14,6
		BS61	60x16x3	BEU	36	645 (215x3)	2	15,4
		G20	15x18	BEU	120	195	2	13,5
		G44	25x20	BEU	60	335	2	11,9
		G45	40x20x2	BEU	42	542 (271x2)	2	13
		G46	60x20x3	BEU	28	855 (285x3)	2	12,8

MINI I

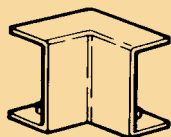

Angolo interno.
Inner bend.

Tipo	Colore	Imballo pz.
Part number	Colour	Packing pcs.

MINI IV

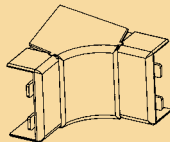

Angolo interno variabile.
Inner variable bend.

Tipo	Colore	Imballo pz.
Part number	Colour	Packing pcs.

MINI G

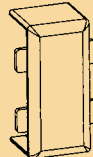

Giunto coperschio.
Cover joint.

Tipo	Colore	Imballo pz.
Part number	Colour	Packing pcs.

MINI L

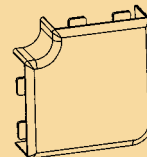

Giunto "L" per derivazione piana.
L-Joint for flat bend.

Tipo	Colore	Imballo pz.
Part number	Colour	Packing pcs.

MINI41I	BEU	40 (4x10)
MINI41I	BEU	40 (4x10)
MINI30I	BEU	40 (4x10)
MINI40I	BEU	40 (4x10)
MINI11I	BEU	40 (4x10)
MINI21I	BEU	40 (4x10)
MINI31I	BEU	40 (4x10)
MINI61I	BEU	40 (4x10)
MINI44I	BEU	20 (4x5)
GT248I ▲	BEU	10 (2x5)
GT244I ▲	BEU	10

MINI41IV	BEU	40 (4x10)
MINI41IV	BEU	40 (4x10)
MINI21IV	BEU	40 (4x10)
MINI31IV	BEU	40 (4x10)

MINI41G	BEU	40 (4x10)
MINI41G	BEU	40 (4x10)
MINI30G	BEU	40 (4x10)
MINI40G	BEU	40 (4x10)
MINI11G	BEU	40 (4x10)
MINI21G	BEU	40 (4x10)
MINI31G	BEU	40 (4x10)
MINI61G	BEU	40 (4x10)
MINI44G	BEU	20 (4x5)
GT248G ▲	BEU	20 (4x5)
GT244G ▲	BEU	20 (4x5)

MINI41L	BEU	40 (4x10)
MINI41L	BEU	40 (4x10)
MINI30L	BEU	40 (4x10)
MINI40L	BEU	40 (4x10)
MINI11L	BEU	40 (4x10)
MINI21L	BEU	40 (4x10)
MINI31L	BEU	40 (4x10)
MINI61L	BEU	20 (2x10)
MINI44L	BEU	20 (4x5)
GT248L ▲	BEU	10 (2x5)
GT244L ▲	BEU	10

□ BEU = Bianco / White Type 9010

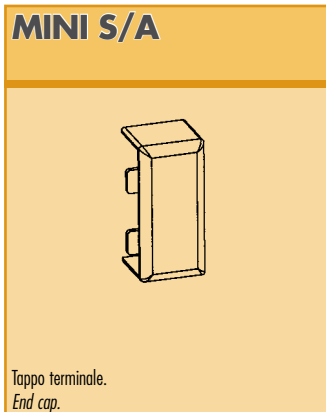
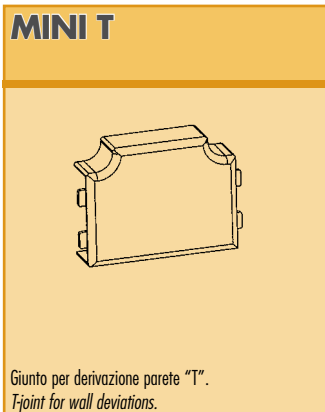

GWT = T850°

Tipo	Colore	BxH mm
Part number	Colour	BxH mm

Tipo	Colore	Imballo pz.
Part number	Colour	Packing pcs.

Tipo	Colore	Imballo pz.
Part number	Colour	Packing pcs.

Tipo	Colore	Imballo pz.
Part number	Colour	Packing pcs.

G41	BEU	20x10
MS201	BEU	20x10
MS301	BEU	30x10
MS4010	BEU	40x10
BS11	BEU	16x16
BS21	BEU	25x16
BS31	BEU	40x16
BS61	BEU	60x16
G20	BEU	15x18
G44	BEU	25x20
G45	BEU	40x20
G46	BEU	60x20

MINI41T	BEU	40 (4x10)
MINI41T	BEU	40 (4x10)
MINI30T	BEU	40 (4x10)
MINI40T	BEU	40 (4x10)
MINI11T	BEU	40 (4x10)
MINI21T	BEU	40 (4x10)
MINI31T	BEU	40 (4x10)
MINI61T	BEU	20 (2x10)
MINI44T	BEU	20 (4x5)
GT248T ▲	BEU	10 (2x5)
GT244T ▲	BEU	10

MINI41S	BEU	40 (4x10)
MINI41S	BEU	40 (4x10)
MINI30S	BEU	40 (4x10)
MINI40S	BEU	40 (4x10)
MINI11S	BEU	40 (4x10)
MINI21S	BEU	40 (4x10)
MINI31S	BEU	40 (4x10)
MINI61S	BEU	40 (4x10)
GT16A ▲	BEU	20 (4x5)
GT248A ▲	BEU	20 (4x5)
GT244A ▲	BEU	10 (2x5)

VPGRM	BEU	36 (6x6)
VPGRM	BEU	36 (6x6)
VPGRM	BEU	36 (6x6)
VPGRM	BEU	36 (6x6)
VPGRM	BEU	36 (6x6)
VPGRM	BEU	36 (6x6)

▲ = Ricavare dalla misura più grande. Get from bigger size.

RMCP

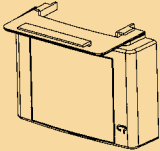

Raccordo per scatole portautenze.
Canali: min 20x10 - max 60x16
Socket box junction.
Trunkings: min 20x10 - max 60x16.

Tipo	Colore	Imballo pz.
Part number	Colour	Packing pcs.

SCS

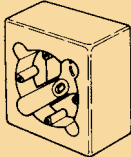

Scatola portautenze con interasse 60/55.
Socket box for switches with centres of 60/55.

Tipo	Colore	Imballo pz.
Part number	Colour	Packing pcs.

SC503



Scatola portautenze con interasse 83,5 (Mod. 503).
Pareti prefabbricate per l'ingresso dei minicanali.
Socket box for switches with centres of 83,5 (Mod.503). Prefabricated walls for minitrunkings entry.
GWT= T850°

Tipo	Colore	Imballo pz.
Part number	Colour	Packing pcs.

VPG18S

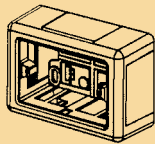

Scatola portautenze con interasse 83,5 (Mod. 503).
Socket box for switches with centres of 83,5 (Mod.503).

Tipo	Colore	Imballo pz.
Part number	Colour	Packing pcs.

RMCP	BEU	10
RMCP	BEU	10
RMCP	BEU	10
RMCP	BEU	10
RMCP	BEU	10
RMCP	BEU	10
RMCP	BEU	10
RMCP	BEU	10

SCS	BEU	9
SCS	BEU	9
SCS	BEU	9
SCS	BEU	9
SCS	BEU	9
SCS	BEU	9
SCS	BEU	9
SCS	BEU	9

SC503	BE	9
SC503	BE	9
SC503	BE	9
SC503	BE	9
SC503	BE	9
SC503	BE	9
SC503	BE	9
SC503	BE	9
SC503	BE	9
SC503	BE	9
SC503	BE	9

VPG18S	BEU	9
VPG18S	BEU	9
VPG18S	BEU	9
VPG18S	BEU	9
VPG18S	BEU	9
VPG18S	BEU	9
VPG18S	BEU	9
VPG18S	BEU	9
VPG18S	BEU	9

□ BEU/BE= Bianco / White Type 9010

TRI 03

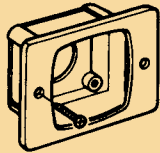

Adattatore per prese telefoniche (per VPG18S).
Adaptor for telephone plugs (for VPG18S).

TRI 05

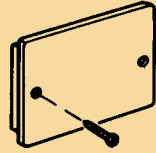

Adattatore per connettori EDP (per VPG18S).
Adaptor for EDP connectors (for VPG18S).

VPG184S

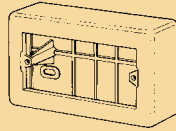

Scatola portautenze con interasse 108 (Mod. 504).
Socket box for switches with centres 108 (Mod. 504).

GWT = T850°

Tipo	Colore	BxH mm
Part number	Colour	BxH mm

Tipo	Colore	Imballo pz.
Part number	Colour	Packing pcs.

Tipo	Colore	Imballo pz.
Part number	Colour	Packing pcs.

Tipo	Colore	Imballo pz.
Part number	Colour	Packing pcs.

G41	BEU	20x10
MS201	BEU	20x10
MS301	BEU	30x10
MS4010	BEU	40x10
BS11	BEU	16x16
BS21	BEU	25x16
BS31	BEU	40x16
BS61	BEU	60x16
G20	BEU	15x18
G44	BEU	25x20
G45	BEU	40x20
G46	BEU	60x20

TRI03 ■	BEU	12
TRI03 ■	BEU	12
TRI03 ■	BEU	12
TRI03 ■	BEU	12
TRI03 ■	BEU	12
TRI03 ■	BEU	12
TRI03 ■	BEU	12
TRI03 ■	BEU	12
TRI03 ■	BEU	12

TRI05 ■	BEU	12
TRI05 ■	BEU	12
TRI05 ■	BEU	12
TRI05 ■	BEU	12
TRI05 ■	BEU	12
TRI05 ■	BEU	12
TRI05 ■	BEU	12
TRI05 ■	BEU	12
TRI05 ■	BEU	12

VPG184S	BEU	9
VPG184S	BEU	9
VPG184S	BEU	9
VPG184S	BEU	9
VPG184S	BEU	9
VPG184S	BEU	9
VPG184S	BEU	9
VPG184S	BEU	9
VPG184S	BEU	9

■ = Fornibile a richiesta e per quantità da concordare. Available on request and for quantities to be agreed.

VPGTC4

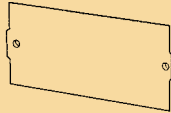

Coperchio di chiusura per VPG184S usata come scatola di derivazione.
Closing cover for VPG184S used as junction box.

Tipo	Colore	Imballo pz.
Part number	Colour	Packing pcs.

VPG186S



Scatola portautenze con interasse 100 (6 posti).
(Interasse 60/70 per utenze estere).
Socket box for switches with centres of 100
(6 places). (Centres 60/70 for foreign switches).

Tipo	Colore	Imballo pz.
Part number	Colour	Packing pcs.

VPG1812S

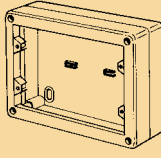

Scatola portautenze con interasse 164x2 (12 posti).
Socket box for switches with centres 164x2 (12 places).

Tipo	Colore	Imballo pz.
Part number	Colour	Packing pcs.

VPM12

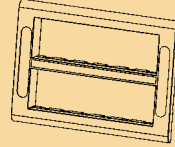

Placca portautenze (12 posti) per scatola VPG1812S.
Front plate socket panel (12 places) for VPG1812S box.

Tipo	Colore	Imballo pz.
Part number	Colour	Packing pcs.

VPGTC4	BE	27
VPGTC4	BE	27
VPGTC4	BE	27
VPGTC4	BE	27
VPGTC4	BE	27
VPGTC4	BE	27
VPGTC4	BE	27
VPGTC4	BE	27

VPG186S	BEU	6
VPG186S	BEU	6
VPG186S	BEU	6
VPG186S	BEU	6
VPG186S	BEU	6
VPG186S	BEU	6
VPG186S	BEU	6
VPG186S	BEU	6

VPG1812S	BE	4
VPG1812S	BE	4
VPG1812S	BE	4
VPG1812S	BE	4
VPG1812S	BE	4
VPG1812S	BE	4
VPG1812S	BE	4
VPG1812S	BE	4

VPM12AV (AVE-S45)	BE	8
VPM12GW GEWISS-Serie 20	BE	8
VPM12SIM SIEMENS-Futura	BE	8
VPM12VIM VIMAR-Idea	BE	8
VPM12TIN TICINO-International	BE	8

□ BEU/BE= Bianco / White Type 9010

SCM17



Scatola di derivazione per minicanali.
 H max = 20 mm L max = 60 mm
 Junction box for minitrunking
 max height = 20 mm max length = 60 mm

SCM090



Scatola di derivazione per minicanali.
 min 20x10 max 60x30
 Junction box for minitrunking.
 min 20 x 10 max 60 x 30

TRS15MN



Raccordo tra scatola TRS1440e centralino TRS16 con minicanali H10 - 16.
 Junction between TRS1440 box and TRS16 switchboard with minitrunking H10 - 16.

GWT = T850°

Tipo	Colore	BxH mm
Part number	Colour	BxH mm

Tipo	Colore	Imballo pz.
Part number	Colour	Packing pcs.

Tipo	Colore	Imballo pz.
Part number	Colour	Packing pcs.

Tipo	Colore	Imballo pz.
Part number	Colour	Packing pcs.

G41	BEU	20x10
MS201	BEU	20x10
MS301	BEU	30x10
MS4010	BEU	40x10
BS11	BEU	16x16
BS21	BEU	25x16
BS31	BEU	40x16
BS61	BEU	60x16
G20	BEU	15x18
G44	BEU	25x20
G45	BEU	40x20
G46	BEU	60x20

SCM17	BEU	10
SCM17	BEU	10
SCM17	BEU	10
SCM17	BEU	10
SCM17	BEU	10
SCM17	BEU	10
SCM17	BEU	10
SCM17	BEU	10
SCM17	BEU	10
SCM17	BEU	10
SCM17	BEU	10
SCM17	BEU	10
SCM17	BEU	10
SCM17	BEU	10
SCM17	BEU	10
SCM17	BEU	10
SCM17	BEU	10

SCM090	BEU	10
SCM090	BEU	10
SCM090	BEU	10
SCM090	BEU	10
SCM090	BEU	10
SCM090	BEU	10
SCM090	BEU	10
SCM090	BEU	10
SCM090	BEU	10
SCM090	BEU	10
SCM090	BEU	10
SCM090	BEU	10
SCM090	BEU	10
SCM090	BEU	10
SCM090	BEU	10
SCM090	BEU	10
SCM090	BEU	10

TRS15MN	BE	20
TRS15MN	BE	20
TRS15MN	BE	20
TRS15MN	BE	20
TRS15MN	BE	20
TRS15MN	BE	20
TRS15MN	BE	20
TRS15MN	BE	20
TRS15MN	BE	20
TRS15MN	BE	20
TRS15MN	BE	20
TRS15MN	BE	20
TRS15MN	BE	20
TRS15MN	BE	20
TRS15MN	BE	20
TRS15MN	BE	20

TRS1440

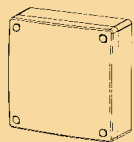

Scatola di derivazione per canali altezza max 40.
Junction box. For trunking max H = 40

Tipo	Colore	Imballo pz.
Part number	Colour	Packing pcs.

TRS16

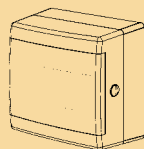

Centralino a 7 moduli.
Switchboard at 7 modules.

Tipo	Colore	Imballo pz.
Part number	Colour	Packing pcs.

TS



Tassello ad espansione per il fissaggio dei canali a parete, 2-3 per m. Completamente isolato, con testa vite a scomparsa.

Wall plug. For wall-mounting of the ducting (2-3 per meter). Completely isolated, with a countersunk screw.
Dim.: Ø 6 mm Colore/Colour: Nero/Black

Tipo	Colore	Imballo pz.
Part number	Colour	Packing pcs.

MCE15



Cesoia per taglio minicanali (anche ad angoli variabili) spessore max 15 mm.

Minitrunkings cutting tool. Max thickness 15 mm.

Tipo	Colore	Imballo pz.
Part number	Colour	Packing pcs.

TRS1440	BE	3
TRS1440	BE	3
TRS1440	BE	3
TRS1440	BE	3
TRS1440	BE	3
TRS1440	BE	3
TRS1440	BE	3
TRS1440	BE	3
TRS1440	BE	3
TRS1440	BE	3

TRS16	BE	3
TRS16	BE	3
TRS16	BE	3
TRS16	BE	3
TRS16	BE	3
TRS16	BE	3
TRS16	BE	3
TRS16	BE	3
TRS16	BE	3
TRS16	BE	3

TS	■	100
----	---	-----

MCE15		1
-------	--	---

MLA15



Lama di ricambio per MCE15.
Spare blade for MCE15.

Tipo	Colore	Imballo pz.
Part number	Colour	Packing pcs.

MLA15		1
-------	--	---

□ BEU/BE= Bianco / White Type 9010

2

MINICANALI, CANALI PER IMPIANTI, CANALI PORTAUTENZE
MINITRUNKINGS, CABLE DUCTINGS, INSTALLATION TRUNKINGS

Dati tecnici.

Technical data.

Tipo / Type	Sezione geometrica Working section mm ²	Numero conduttori mm ² N. of electric wires mm ²				Ø max cavo cable	MINI E MINI EV	MINI I MINI IV	MINI L	MINI T	MINI G	MINI S MINI A	
		1,5	2,5	4	6								
		Raggio curvatura cavi mm / Cable blending radius mm											
G41 20x10		128	8	6	4	3	8						
MS201 20x10		128	8	6	4	3	8						
MS301 30x10		208	9	7	5	4	8						
MS4010 40x10		A 125 B 125	7	5	3	2	8						
BS11 16x16		180	10	8	6	4	12						
BS21 25x16		320	18	14	9	6	12						
BS31 40x16		A 215 B 215	18	12	9	5	12						
BS61 60x16		A 215 B 215 C 215	18	12	9	5	12						
G20 15x18		195	10	8	6	4	12						
G44 25x20		335	18	14	9	6	17						
G45 40x20		A 271 B 271	16	11	7	5	17						
G46 60x20		A 285 B 285 C 285	15	11	7	5	17						

Dati tecnici. Technical data.

RMCP

Raccordo per scatole porta utenze.
Junction of socket boxes.
91x63x24 mm

Per canali / *For trunkings*
min 20x10 mm - max 60x16 mm

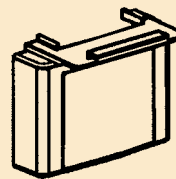
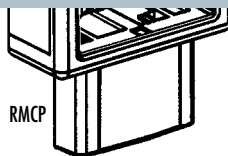
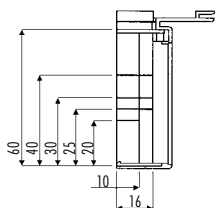

Fratturare lungo le linee pretracciate, secondo la dimensione del canale.
Cut along the pre-cut lines, according to the dimension of the trunking.

VPGRM

Adattatore per derivare minicanali dalle scatole porta utenze.
Adaptor for junction between minitrunkings and socket boxes.

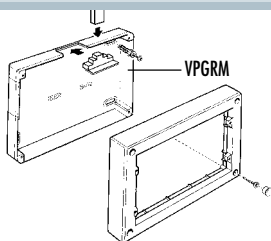
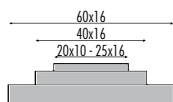

Inserire sulla parete pretranciata della scatola l'accessorio VPGRM adattato alle misure del minicanale. Posizionare e fissare la scatola al muro.

Insert on the pre-cut wall of the box the VPGRM accessory according to the minitrunking size. Place and fix the box onto the wall.

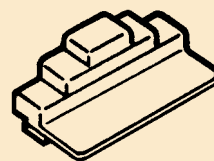

TRS1440

Scatola di derivazione.
Junction box.
150x150x65 mm

Per derivare, sui 4 lati, canali sino a 120x40 mm (Tipo G).
For junction, on all sides, 120x40 mm trunking (Type G).

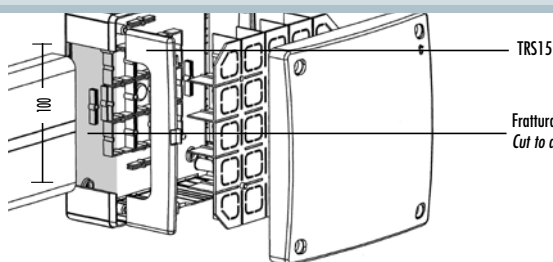

Fratturare per adattare.
Cut to adapt.

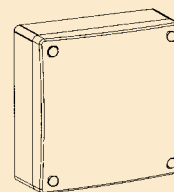

TRS15MN

Adattatore.
Junction box.
140x40 mm

Minicanali derivabili con l'utilizzo dell'accessorio TRS15MN.
Minitrunkings derivations with accessory TRS15MN.

Per derivare dalle scatole TRS1440 e dal centralino TRS16.
For junction between the TRS1440 boxes and the TRS16 switchboard.
Minicanali / *Minitrunkings* H=10-16-20 mm.

BxH	BxH	BxH
20 x 10	25 x 16	25 x 20
30 x 10	40 x 16	40 x 20
40 x 10	60 x 16	60 x 20
60 x 10		

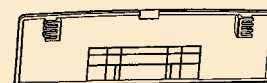

TRS16

Centralino a 7 moduli.
Switchboard at 7 modules.
150x150x90 mm

7 moduli max. Possibilità di derivare canali solo sul lato superiore ed inferiore.
Max 125x50. Potenza massima dissipabile: 9 Watt secondo norme CEI 23-48, 23-49.

7 modules max. *Junction of the trunkings, on higher and lower sides only.* Max 125x50. Max dissipable power: 9 Watt, according CEI standard 23-48, 23-49.

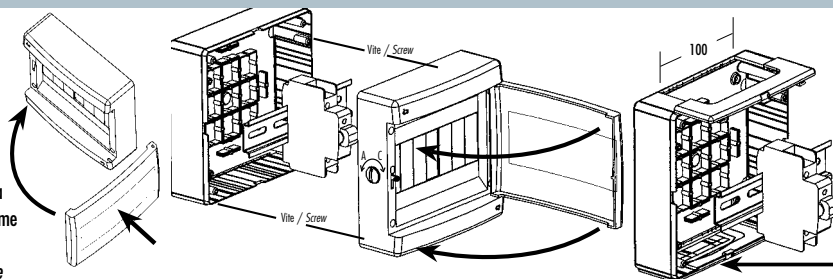

Fissare centralmente il profilo Omega sul fondo della scatola (con le viti in dotazione) nelle sedi contrassegnate. Incastrare gli interruttori e procedere al loro cablaggio. Montare il coperchio ed il coperchietto trasparente fissando con le apposite viti.
Centrally fix the profile Omega on the bottom of the box (with the supplied screws) in the marked points. Insert the interrupters and progress to their wiring. Climb on the cover and the transparent little cover fixing with the special screws.

Ingressi canali e adattatori.
Trunkings and adaptor entries.

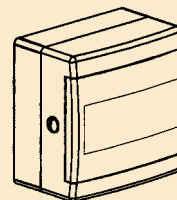

2

MINICANALI, CANALI PER IMPIANTI, CANALI PORTAUTENZE
MINITRUNKINGS, CABLE DUCTINGS, INSTALLATION TRUNKINGS

Dati tecnici. Technical data.

RMCP

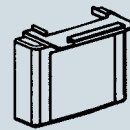

Raccordo per scatole porta utenze.
Junction of socket boxes.

SCS

Accessori specifici per ogni singola scatola portautenze.
Specific accessories for each socket box.

Interasse / Interaxis
60/55 mm
100x90x50 mm

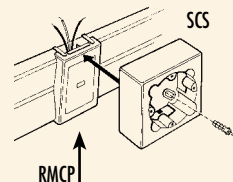

VPG18S

TRI03

TRI05

Interasse / Interaxis
83,5 mm (mod. 503)
130x90x50 mm

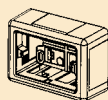

Adattatore per prese telefoniche.
Adaptor for telephone plugs.



Adattatore per connettori EDP o coperchio di chiusura per VPG18S usata come scatola di derivazione.
Adaptor for EDP connectors or closing cover for VPG18S used as junction box.

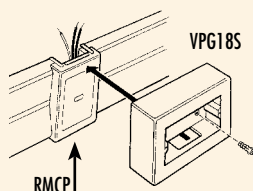

VPG184S

VPGTC4

Interasse / Interaxis
108 mm (mod. 504)
150x90x50 mm

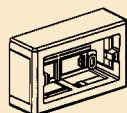

Coperchio di chiusura per VPG184S usata come scatola di derivazione.
Closing cover for VPG184S used as junction box.
125x65 mm

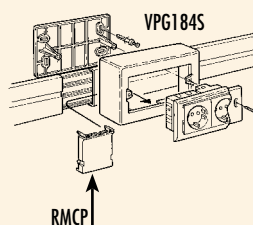
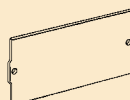

VPG186S

Interasse / Interaxis
100 mm - 6 posti / places
60/70 mm
202x92x63 mm

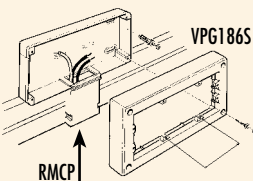
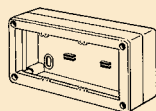

VPG1812S

VPM12

Interasse / Interaxis
164 mm x 2 - 12 posti / places
202x150x63 mm

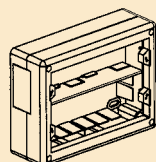

Placca porta utenze. (12 posti)
Front plate socket panel. (12 places)
190x140 mm

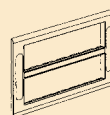

Fratturare le lamelle per il passaggio dei cavi dove necessario. Break along fracture line where required.

