

LINEADIN®

Canali per installazione completo di coperchio smontabile con attrezzo (secondo norme DIN).
Installation trunking, including cover removable by tool (in accordance with DIN standards).



pagina / page

2.5.6

Dati tecnici.
Technical data.



pagina / page

2.5.18

LINEADIN LDC.

Elementi del sistema a parete.

Wall system components.

LDC

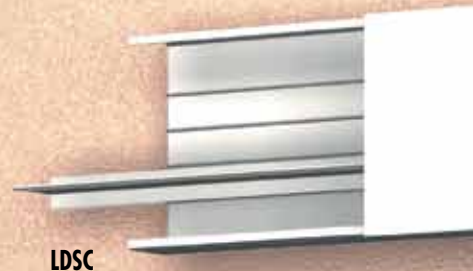

LDSC

DM105



PD



DM100



LDI

LDM
DM075

DM075

LDM
DM071

LDM
DM072



DM071
+DM082

DM100
LDM
DM072

DM082

DM071



DM280
SDG206



DM076

DM070



DM280
SDG206

DM280
SDG206

DM282

LDE

DM280
SDG206

2

LDG1

DMF

LDT

LDP

LDAD

DM071+DM082

LDE

LDSD

LDSD

DM180

MINICANALI, CANALI PER IMPIANTI, CANALI PORTAUTENZE
MINITRUNKINGS, CABLE DUCTINGS, INSTALLATION TRUNKINGS

LINEADIN LDC.

Elementi del sistema sospeso.

Suspension system components.

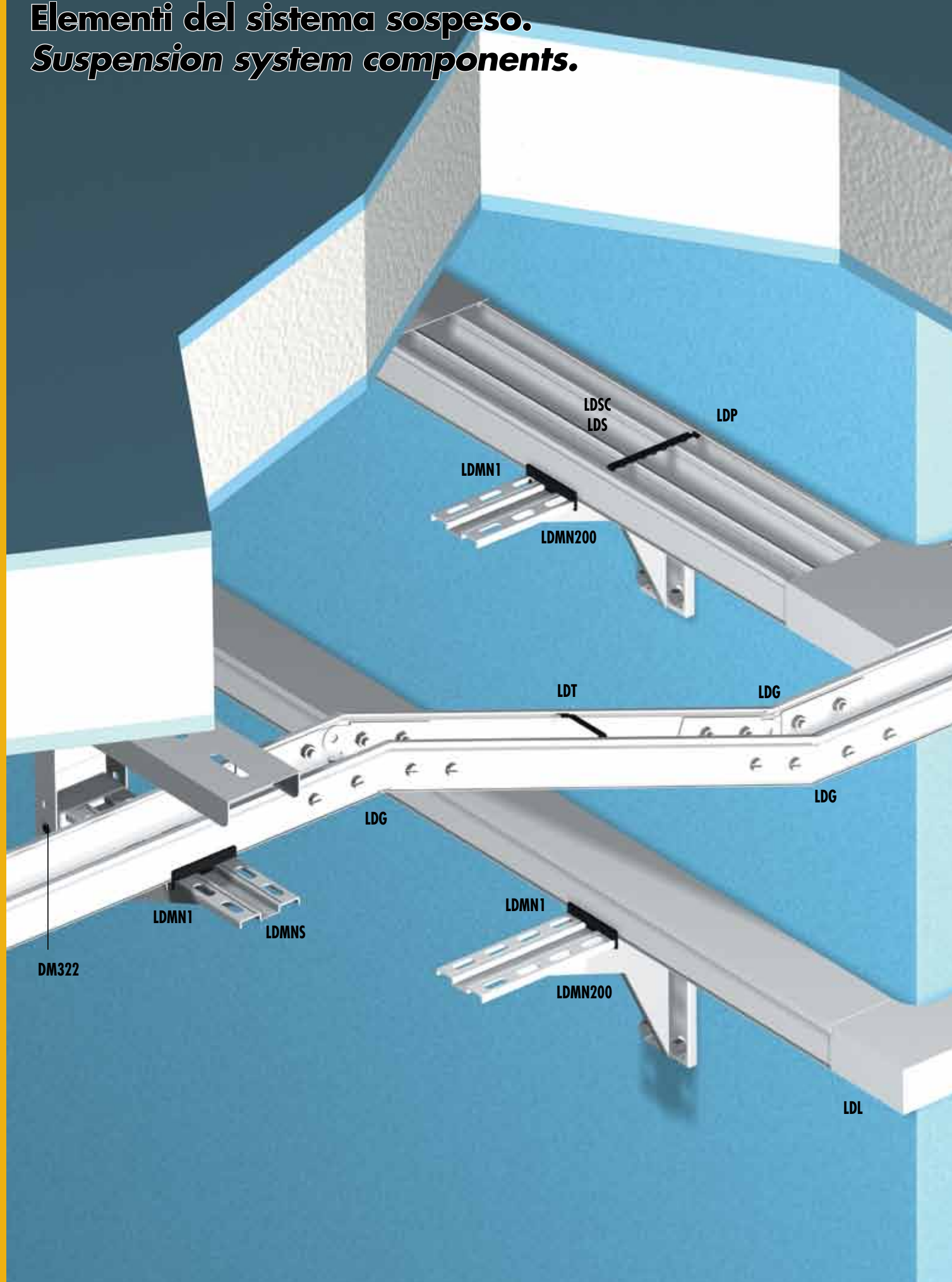

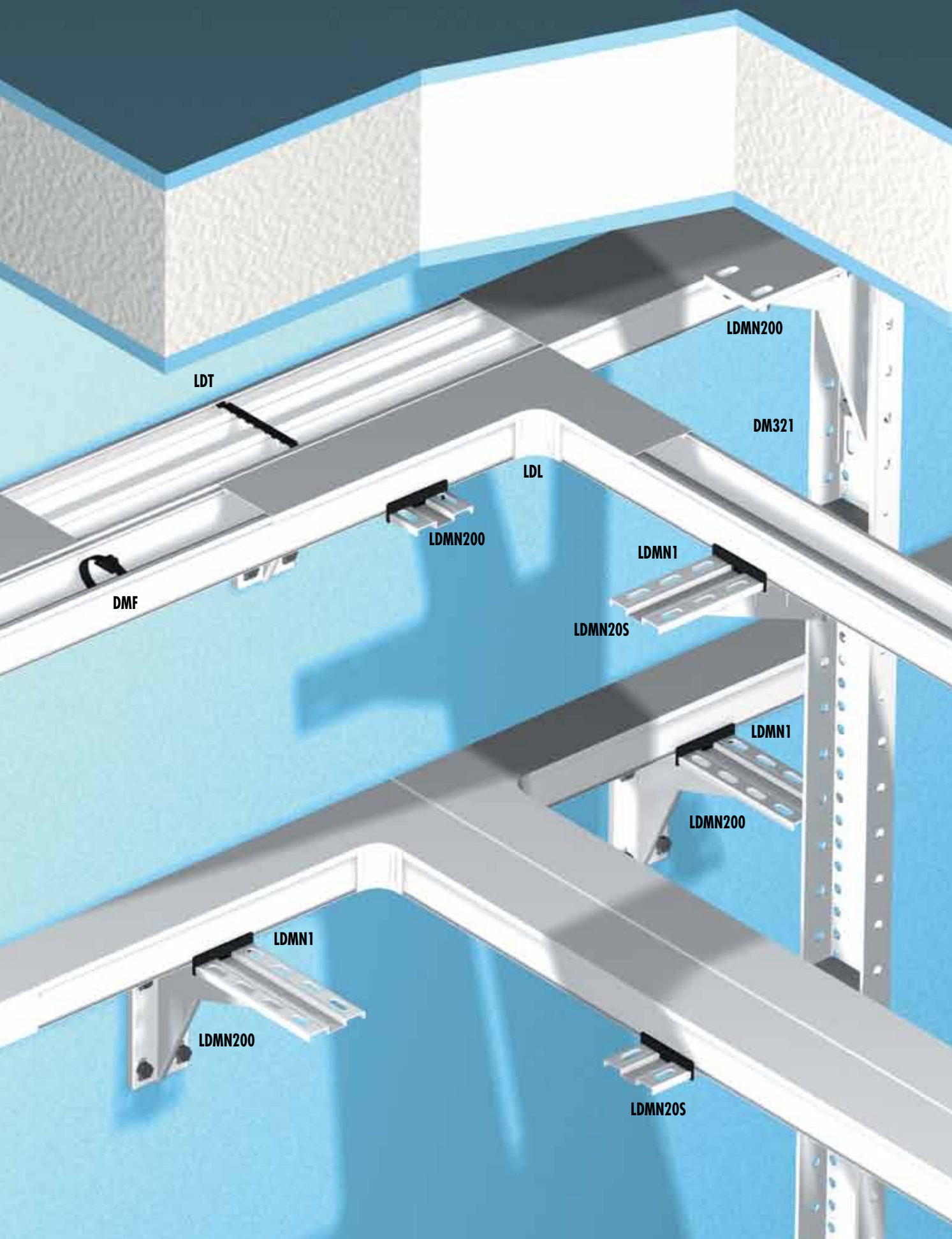

MINICANALI, CANALI PER IMPIANTI, CANALI PORTAUTENZE
MINITRUNKINGS, CABLE DUCTINGS, INSTALLATION TRUNKINGS

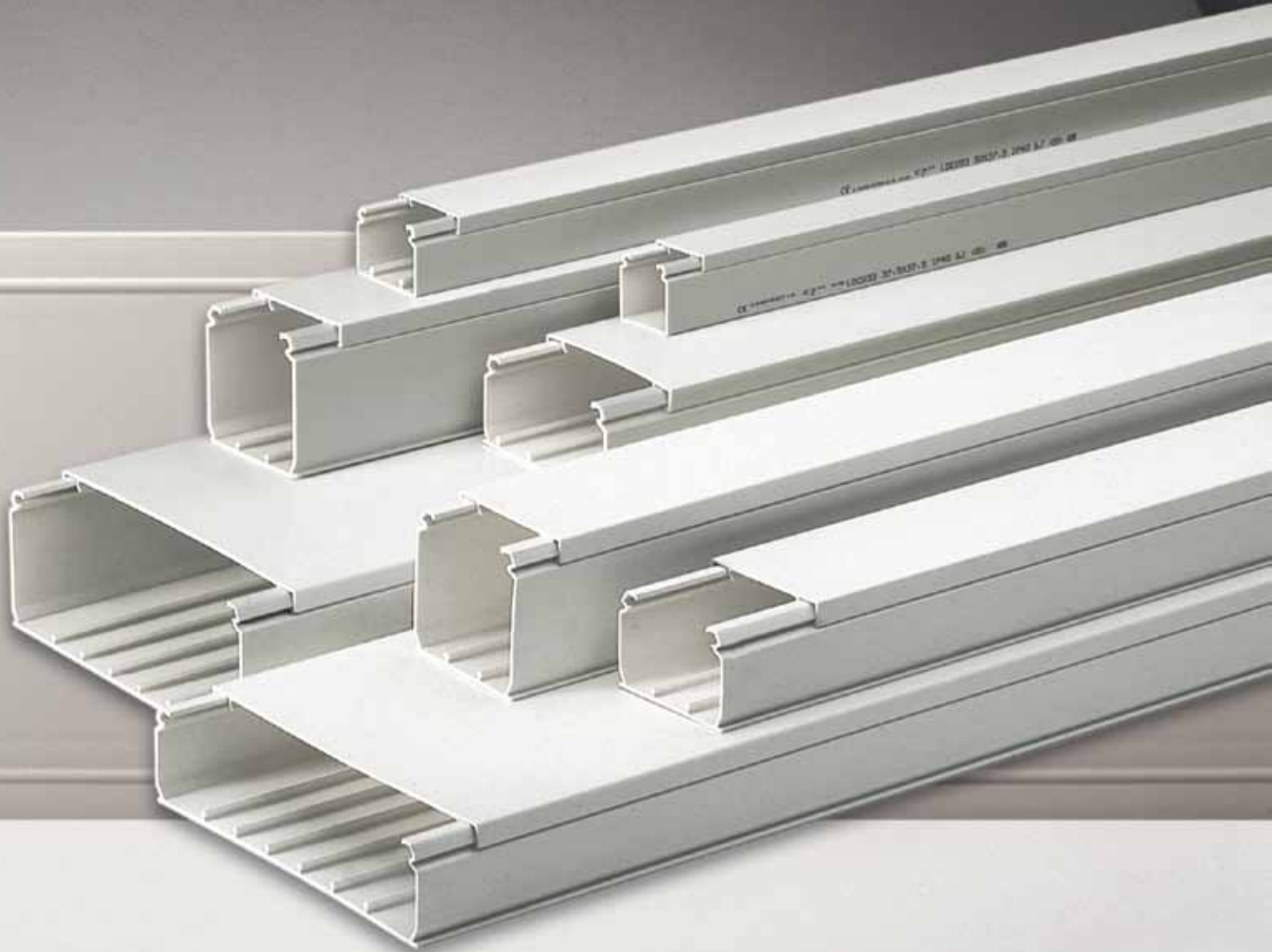

LINEADIN®

Canali per installazione completo di coperchio smontabile con attrezzo (secondo norme DIN)
 Materiale: PVC Rigido Autoestinguente Classe 1 (UL94-VO).
 Lunghezza: 2 metri

*Installation trunking, including cover removable by tool (in accordance with DIN standards).
 Self-extinguishing rigid PVC Class 1 (UL94-VO).
 Length: 2 meters*



IP 40 - GWT = T850°

**Codifica per l'ordine dei canali
 Functional part numbering system**

LDC022

BEU

Tipo
 Type

Colore
 Colour

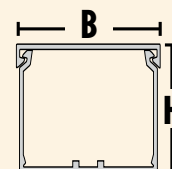

- I canali vengono forniti completi di coperchio.
- All trunkings come complete with cover.

**COLORI
 COLOURS**

















BEU = Bianco / White
 Type 9010

Canali per installazione completo di coperchio smontabile con attrezzo (secondo norme DIN).
Modulo 12,5. PVC Rigido Autoestinguente Classe 1 (UL94-VO).

Installation trunking, including cover removable by tool (in accordance with DIN standards).
Mod. 12,5. Self-extinguishing rigid PVC Class 1 (UL94-VO).

Guide	Sezione fondo	Tipo	Dimensioni BxH mm	Colore	Imballo m	S.G. mm ²	Lung. barre m	Cartone peso Kg
Rails	Section of the bottom	Part number	Duct Size BxH mm	Colour	Standard Carton m	G.S. mm ²	Length m	Carton Weight Kg

		LDC022	25x25	BEU	80	440	2	18,4
		LDC032	37,5x25	BEU	52	645	2	17
		LDC033	37,5x37,5	BEU	36	1075	2	14,5
▲		LDC053	50x37,5	BEU	28	1520	2	14,4
▲		LDC055	50x50	BEU	24	2126	2	14
▲		LDC075	75x50	BEU	20	3115	2	18
▲		LDC105	100x50	BEU	16	4270	2	16,6
▲		LDC125	125x50	BEU	20	5350	2	24,7
▲		LDC155	150x50	BEU	12	6320	2	18,4
▲		LDC205	200x50	BEU	12	8590	2	23,8
▲		LDC077	75x75	BEU	20	4890	2	21,9
▲		LDC107	100x75	BEU	16	6670	2	21,3
▲		LDC127	125x75	BEU	12	8350	2	18,6
▲		LDC157	150x75	BEU	8	9945	2	14,5
▲		LDC207	200x75	BEU	8	13465	2	18

▲ Canali con guide sul fondo. Trunkings with rails on the bottom.

DM071



Mostrina cieca per presa telefonica e accessorio DM082.
Closed plate for lt. phone socket and DM082 accessory.

Tipo	Colore	Imballo pz.
Part number	Colour	Packing pcs.

DM072TT

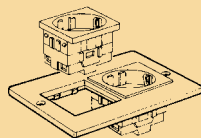

Mostrina per il montaggio di N. 2 prese SCHUKO e moduli singoli per TICINO TT MAGIC.
Plate for mounting of 2 SCHUKO sockets and single modules for TICINO TT MAGIC.

Tipo	Colore	Imballo pz.
Part number	Colour	Packing pcs.

DM072VIP

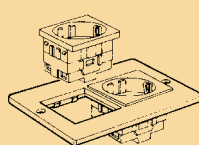

Mostrina per il montaggio di N. 2 prese SCHUKO e moduli singoli per VIMAR PLANA.
Plate for mounting of 2 SCHUKO sockets and single modules for VIMAR PLANA.

Tipo	Colore	Imballo pz.
Part number	Colour	Packing pcs.

DM072AV

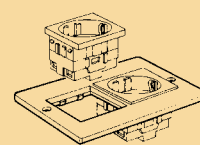

Mostrina per il montaggio di 2 prese SCHUKO e moduli singoli per AVE - Blanc/Noir.
Plate for mounting of 2 SCHUKO sockets and single modules for AVE - Blanc/Noir.

Tipo	Colore	Imballo pz.
Part number	Colour	Packing pcs.

DM071	BEU	20
DM071	BEU	20
DM071	BEU	20
DM071	BEU	20

DM072TT	BE	20
DM072TT	BE	20
DM072TT	BE	20
DM072TT	BE	20

DM072VIP	BE	20
DM072VIP	BE	20
DM072VIP	BE	20
DM072VIP	BE	20

DM072AV	BE	20
DM072AV	BE	20
DM072AV	BE	20
DM072AV	BE	20

2

DM075

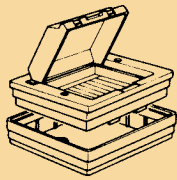

Mostina per magnetotermici orizzontali (max 5) completo di:
 - Coperchio trasparente - Profilato Omega
 - Distanziale - 3 viti met. di fissaggio
 Plate for horizontal MCB switches (max 5) complete with:
 - Transparent cover - Omega profile
 - Spacer - 3 metal fixing screws

Tipo	Colore	Imballo pz.
Part number	Colour	Packing pcs.

DM082

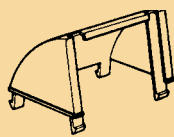

Adattatore per connettori EDP compreso di:
 - Placchetta per connettori D-SUB (a vaso) 9/15/25 contatti
 - Placc. per connettori DIN - Placchetta senza fori per connettori
It. socket adaptor. Includes:
 - Plate for D-SUB computer links (bowl) 9/15/25 contacts -
 Plate for two DIN computer links
 - Plate without holes for computer links
 Colore/Colour: Nero/Black

Tipo	Colore	Imballo pz.
Part number	Colour	Packing pcs.

LDSC

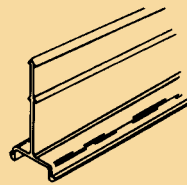

Separatore centrale. Lunghezza barre: 1 m
 Central separator. Length: 1 m.
 Colore/Colour: Grigio chiaro/Light Grey

Tipo	Colore	Imballo m.
Part number	Colour	Packing m.

LDS

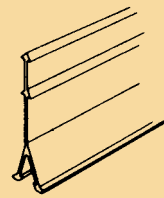

Separatore laterale. Lunghezza barre: 1 m
 Lateral separator. Length: 1 m.
 Colore/Colour: Grigio chiaro/Light Grey

Tipo	Colore	Imballo m.
Part number	Colour	Packing m.

DM075	BEU	10
DM075	BEU	10
DM075	BEU	10

DM082	■	20

LDSC50	□	50
LDSC50	□	50
LDSC50	□	50
LDSC50	□	50
LDSC50	□	50
LDSC50	□	50
LDSC75	□	25
LDSC75	□	25
LDSC75	□	25
LDSC75	□	25
LDSC75	□	25

LDS50	□	50
LDS50	□	50
LDS50	□	50
LDS50	□	50
LDS50	□	50
LDS50	□	50
LDS75	□	50
LDS75	□	50
LDS75	□	50
LDS75	□	50
LDS75	□	50

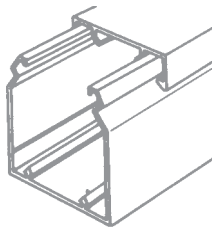

IP 40 - GWT = T850°

Guide	Tipo	Colore	BxH mm
Rails	Part number	Colour	BxH mm

	LDC022	BEU	25x25
	LDC032	BEU	37,5x25
	LDC033	BEU	37,5x37,5
▲	LDC053	BEU	50x37,5
▲	LDC055	BEU	50x50
▲	LDC075	BEU	75x50
▲	LDC105	BEU	100x50
▲	LDC125	BEU	125x50
▲	LDC155	BEU	150x50
▲	LDC205	BEU	200x50
▲	LDC077	BEU	75x75
▲	LDC107	BEU	100x75
▲	LDC127	BEU	125x75
▲	LDC157	BEU	150x75
▲	LDC207	BEU	200x75

FMC

Fermacavo universale per canali Tipo G, LDC e Dominio.
Cable fastner for Tipo G, LDC and Dominio
Colore/Colour: Nero/Black

Tipo	Colore	Imballo pz.
Part number	Colour	Packing pcs.

FMC	■	40 (4X10)
FMC	■	40 (4X10)
FMC	■	40 (4X10)
FMC	■	40 (4X10)
FMC	■	40 (4X10)
FMC	■	40 (4X10)
FMC	■	40 (4X10)
FMC	■	40 (4X10)
FMC	■	40 (4X10)
FMC	■	40 (4X10)
FMC	■	40 (4X10)
FMC	■	40 (4X10)
FMC	■	40 (4X10)
FMC	■	40 (4X10)

LDP

Traversino per separatore.
Cross arm for separator.
Colore/Colour: Nero/Black

Tipo	Colore	Imballo pz.
Part number	Colour	Packing pcs.

LDP50	■	500 (5X100)
LDP75	■	300 (3X100)
LDP100	■	150 (2X75)
LDP125	■	130 (2X65)
LDP150	■	50
LDP200	■	50
LDP75	■	300 (3X100)
LDP100	■	150 (2X75)
LDP125	■	130 (2X65)
LDP150	■	50
LDP200	■	50

LDT

Traversino per contenimento cavi.
Cross arm for cables retention.
Colore/Colour: Nero/Black

Tipo	Colore	Imballo pz.
Part number	Colour	Packing pcs.

LDT50	■	500 (5X100)
LDT50	■	500 (5X100)
LDT75	■	300 (3X100)
LDT100	■	200(2X100)
LDT125	■	150 (2X75)
LDT150	■	50
LDT200	■	50
LDT75	■	300 (3X100)
LDT100	■	200 (2X100)
LDT125	■	150 (2X75)
LDT150	■	50
LDT200	■	50

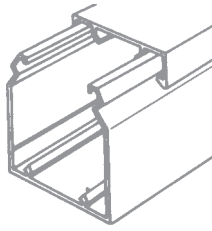

IP 40 - GWT = T850°

Guide	Tipo	Colore	BxH mm
Rails	Part number	Colour	BxH mm

	LDC022	BEU	25x25
	LDC032	BEU	37,5x25
	LDC033	BEU	37,5x37,5
▲	LDC053	BEU	50x37,5
▲	LDC055	BEU	50x50
▲	LDC075	BEU	75x50
▲	LDC105	BEU	100x50
▲	LDC125	BEU	125x50
▲	LDC155	BEU	150x50
▲	LDC205	BEU	200x50
▲	LDC077	BEU	75x75
▲	LDC107	BEU	100x75
▲	LDC127	BEU	125x75
▲	LDC157	BEU	150x75
▲	LDC207	BEU	200x75

LD I

Angolo interno.
Inner bend.

Tipo	Colore	Imballo pz.
Part number	Colour	Packing pcs.

LD022I	BEU	25
LD032I	BEU	20
LD033I	BEU	20
LD053I	BEU	12
LD055I	BEU	12
LD075I	BEU	16
LD105I	BEU	15
LD125I	BEU	10
LD155I	BEU	10
LD205I	BEU	4
LD077I	BEU	15
LD107I	BEU	4
LD127I	BEU	4
LD157I	BEU	4
LD207I	BEU	4

LD A

Tappo terminale.
End cap.

Tipo	Colore	Imballo pz.
Part number	Colour	Packing pcs.

LD022A	BEU	25
LD032A	BEU	20
LD033A	BEU	20
LD053A	BEU	20
LD055A	BEU	20
LD075A	BEU	20
GT100A ▲	BEU	10
LD127A ▲	BEU	10
LD155A	BEU	10
LD205A	BEU	10
LD077A	BEU	10
GT100A ▲	BEU	10
LD127A	BEU	10
LD157A	BEU	10
LD207A	BEU	10

LD L

Giunto per derivazione piana.
L-joint for wall deviations.

Tipo	Colore	Imballo pz.
Part number	Colour	Packing pcs.

LD022L	BEU	25
LD032L	BEU	20
LD033L	BEU	20
LD053L	BEU	16
LD055L	BEU	16
LD075L	BEU	20
LD105L	BEU	10
LD125L	BEU	8
LD155L	BEU	10
LD205L	BEU	4
LD077L ■	BEU	10
LD107L ■	BEU	4
LD127L ■	BEU	4
LD157L	BEU	4
LD207L	BEU	4

□ = Ricavare dalla misura più grande
Get from bigger sizes

□ = Fornibile a richiesta e per quantità da concordare
Available on request and for quantities to be agreed

LD T

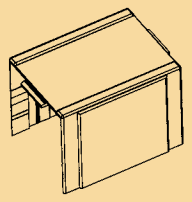

Giunto derivazione a T.
T-joint wall deviations.

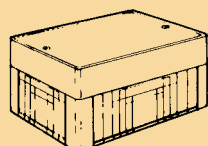

Tipo	Colore	Imballo pz.
Part number	Colour	Packing pcs.

DM070
 Pag./Page 4.1.4 



Scatola di derivazione e portautenze completa di:
 - 1 Mostrina DM071 - 2 Viti metalliche
 - 1 Accessorio non promiscuità cavi
 Junction box and socket point complete with:
 - 1 DM071 plate - 2 Metal screws
 - 1 Cable non-contact accessory

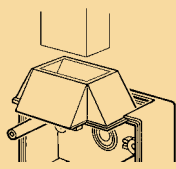

Tipo	Colore	Imballo pz.
Part number	Colour	Packing pcs.

DM076
 Pag./Page 4.1.4 



Adattatore per DM070. Si utilizza con canali aventi larghezza ≤ 60 e con tubo di Ø esterno max 20 mm
 DM070 adaptor. Use with trunkings width ≤ 60 and one pipe of outer Ø max 20 mm.

Tipo	Colore	Imballo pz.
Part number	Colour	Packing pcs.

LDSD
 Pag./Page 4.1.5 

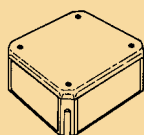

Scatola di derivazione per canali max 125x50/75, min 50x50/75 mm. Completa di separatori cavi e pareti laterali.
 Junction box for trunkings max 125x50/75, min 50x50/75 mm. Complete with cable separation and wall sides.

Tipo	Colore	Imballo pz.
Part number	Colour	Packing pcs.

LD022T	BEU	25
LD032T	BEU	20
LD033T	BEU	20
LD053T	BEU	12
LD055T	BEU	12
LD075T	BEU	12
LD105T	BEU	15
LD125T	BEU	10
LD155T	BEU	10
LD205T	BEU	8
LD077T	BEU	10
LD107T	BEU	4
LD127T	BEU	4
LD157T	BEU	4
LD207T	BEU	4

DM070	BEU	5
DM070	BEU	5
DM070	BEU	5
DM070	BEU	5

DM076	BEU	10
DM076	BEU	10
DM076	BEU	10
DM076	BEU	10

LDSD	BEU	4
LDSD	BEU	4
LDSD	BEU	4
LDSD	BEU	4
LDSD	BEU	4
LDSD75	BEU	3
LDSD75	BEU	3
LDSD75	BEU	3

Dati tecnici. Technical data.

Sezione geometrica e contenenza cavi. Geometric section and cables containment.

	LINEADIN BxH mm	S.G. / G.S. mm ³	Quantità cavi / Quantity of cables mm ²		
			1	1,5	2,5
H 25	25x25	440	42	31	22
	37,5x25	645	61	45	32
H 37,5	37,5x37,5	1075	102	75	54
	50x37,5	1520	144	106	76
H 50	50x50	2126	202	149	106
	75x50	3115	296	218	156
	100x50	4270	406	299	214
	125x50	5350	509	375	268
	150x50	6320	601	443	316
	200x50	8590	817	602	430
H 75	75x75	4890	465	342	245
	100x75	6670	634	467	334
	125x75	8350	794	585	418
	150x75	9945	945	696	497
	200x75	13465	1280	943	673

Dati tecnici carichi del canale. / Trunking loads technical data.

Canale / Trunking L	LDC075		LDC105		LDC125		LDC155		LDC205	
	Q	f	Q	f	Q	f	Q	f	Q	f
500	76	4	79	3,6	81	3,5	83,5	3,4	85	3,3
1000	25	10	27	10	29	10	31	10	33	10
1500	11	15	12	15	13	15	14	15	15	15
2000	6	20	7	20	7	20	8	20	8	20
2500	4	25	4,5	25	4,5	25	5	25	5	25
*Carico / Load Q daN/m	2,3		3,1		3,9		4,8		6,3	

*Il carico Q è riferito ad un coefficiente di riempimento pari al 50% della sezione geometrica del canale. (Norme CEI 23-32).
*The load Q refers to a filling coefficient which is equal to 50% of the geometric section of trunking. (CEI 23-32 standard).

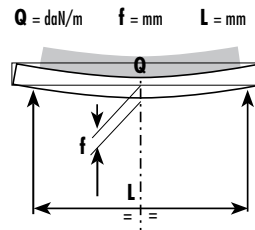

Carichi uniformemente distribuiti Q riferiti a frecce f pari o inferiori all'1% della distanza L tra gli appoggi per canale solo appoggiato. Uniformly distributed loads Q with reference to arrows f equal to or less than 1% of the L distance between trunking supports with trunking just leaning.

Dimensioni e disposizione guide sul fondo per i separatori. Sizes and layout of the rails on the bottom for the separators.

Il canale si fissa a parete con tasselli TS, 2/4 per metro per misure piccole, 4/8 per metro per misure più grandi.
Trunking is fastened to the wall by TS nogs, 2/4 per meter for the smaller sizes, 4/8 per meter for the larger sizes.

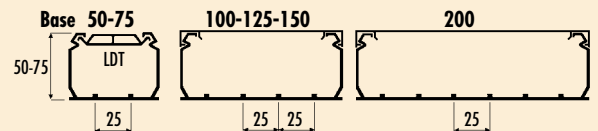

Dimensioni canale Trunking dimensions	N° scomparti N° compartments	Sezione / section mm ²						
		A	B	C	D	E	F	G
LDS								
50 x 50	3	538	1050	538	-	-	-	-
75 x 50	3	1032	1050	1030	-	-	-	-
100 x 50	5	560	1050	1050	1050	560	-	-
125 x 50	5	1100	1050	1050	1050	1100	-	-
150 x 50	5	1585	1050	1050	1050	1585	-	-
200 x 50	7	1670	1050	1050	1050	1050	1050	1670
75 x 75	3	1640	1610	1640	-	-	-	-
100 x 75	5	920	1610	1610	1610	920	-	-
125 x 75	5	1760	1610	1610	1610	1760	-	-
150 x 75	5	2557	1610	1610	1610	2557	-	-
200 x 75	7	2707	1610	1610	1610	1610	1610	2707
LDSC								
50 x 50	2	998	998	-	-	-	-	-
75 x 50	2	1482	1482	-	-	-	-	-
100 x 50	2	2060	2060	-	-	-	-	-
	3	1055	2010	1055	-	-	-	-
125 x 50	2	2600	2600	-	-	-	-	-
	3	1595	2010	1595	-	-	-	-
150 x 50	2	3085	3085	-	-	-	-	-
	3	2080	2010	2080	-	-	-	-
200 x 50	3	3215	2010	3215	-	-	-	-
	4	2210	2010	2010	2210	-	-	-
75 x 75	2	2370	2370	-	-	-	-	-
100 x 75	2	3260	3260	-	-	-	-	-
	3	1682	3155	1682	-	-	-	-
125 x 75	2	4100	4100	-	-	-	-	-
	3	2522	3155	2522	-	-	-	-
150 x 75	2	4897	4897	-	-	-	-	-
	3	3320	3155	3320	-	-	-	-
200 x 75	3	5080	3155	5080	-	-	-	-
	4	3502	3155	3155	3502	-	-	-

LDS

Separatore laterale.
Lateral separator.



LDSC

Separatore centrale.
Central separator.

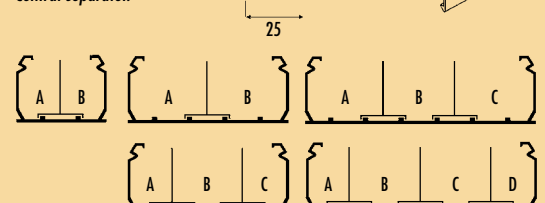

Dati tecnici. Technical data.

DM100

Scatola portautenze per apparecchiature con interasse 60-83,5 mm (2-3 moduli).
Socket point for equipments with interaxis 60-83,5 mm 2-3 modulus.
116x70x60 mm

Per canali Tipo G / For Type G trunkings

DM100 100 - 120 - 150 - 200 x H60

DM104 100 - 80 x H40

DM108 100 - 120 - 150 - 200 x H80

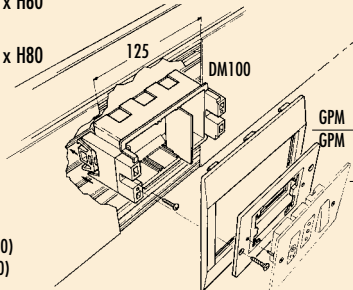
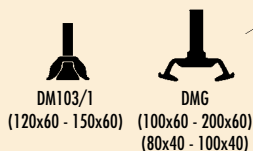

GPM Placca porta mostrine
GPM Panel points plackets

Mostrine
Panels



Sezione d'ingombro 3790 mm² da detrarre alla sezione utile del canale.
Section 3790 sq. mm to be subtracted from usable trunking section.

Per canali LINEADIN / For LINEADIN trunkings

DM100 100 - 125 - 150 - 200 x H50

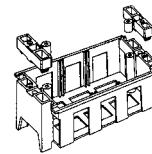

LDM Placca porta mostrine
LDM Panel points plackets

Mostrine
Panels



DM105

Porta apparecchiature modulari (17,5). Max. N° 5.
Holding device for 17,5 modular switches. Max 5
116x40x59 mm

Per canali Tipo G
For Type G trunkings

150 - 200 x H60

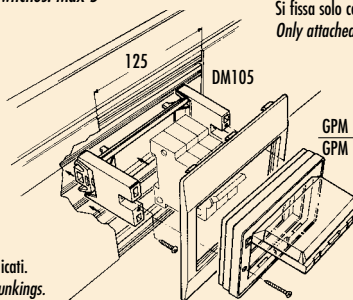
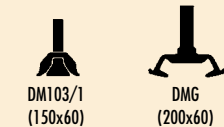

Si fissa solo con l'impiego di DM075
Only attached using DM075

GPM Placca porta mostrine
GPM Panel points plackets

DM075



Sezione d'ingombro 3790 mm² da detrarre alla sezione utile del canale.
Section 3790 sq. mm to be subtracted from usable trunking section.

Per canali LINEADIN / For LINEADIN trunkings

150 - 200 x H50

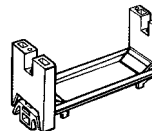

LDM Placca porta mostrine
LDM Panel points plackets

DM075 Mostrina
DM075 Panel



DMF

Tipo	Imballo pz.
Part number	Packing pcs.
DMF	100 (2x50)

Porta fascette che si monta a scatto negli appositi ganci sul fondo interno del canale.
Materiale: Nylon
Cable tie holder which can be snapped on all ducts having a base rail.
Material: Nylon



LDG

Tipo	B x H mm	Per canali H
Part number	B x H mm	For duct H
LDG50	32x200	40
LDG75	58x175	75

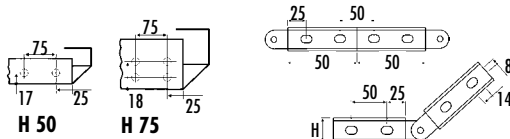

Giunto canali e snodo. Misure esterne dalla base del canale per forare e fissare LDG. Forare le pareti del canale con punta ø 8.
Per formare lo snodo, spezzare a metà il giunto. Trunkings joint and articulated coupling. External dimensions from the base of the trunking for drilling and fixing LDG. Drill with a 8 mm dia bit. To have the articulation, cut the joint in the middle.



FMC

Tipo	Imballo pz.
Part number	Packing pcs.
FMC	40 (4 x10)

Fermacavo universale per canali H.60/80. Applicato sulle guide dei canali impedisce lo spostamento accidentale dei cavi. Può contenere 3 cavi (massimo 5mm di diametro) per ogni foro (2).
Universal cable-holder. For wire ducts H. 60/80. Application on the built-in rail of the duct to avoid accidental pulling of the wires. It can contain 3 wires (of maximum 5mm of diameter) for each hole (2).

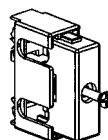

2

MINICANALI, CANALI PER IMPIANTI, CANALI PORTAUTENZE
MINITRUNKINGS, CABLE DUCTINGS, INSTALLATION TRUNKINGS

Mostrine e portamostrine. Panels and front plates holders.

DM071

Mostrina cieca per presa telefonica e accessorio DM082.
Closed plate for lt. phone socket and DM082 accessory.
120x85 mm

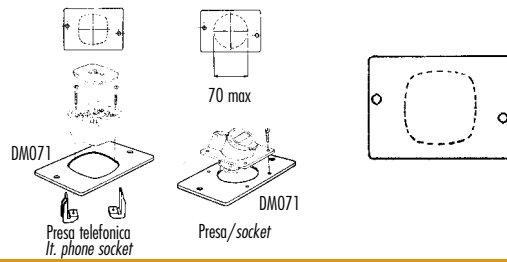

DM072

Mostrina per 4 moduli Gewiss - Ave - Ticino Int.
- Ticino TT - Vimar Plano o 2 prese Schuko.
Plate for 4 Gewiss - Ave - Ticino Int. - Ticino TT
Vimar Plano modules or 2 Schuko socket.
120x85 mm

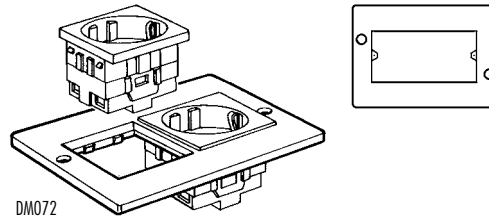

DM073

Mostrina per apparecchiature con interasse 83,5 mm.
Plate for sockets with interaxis 83,5 mm.
120x85 mm

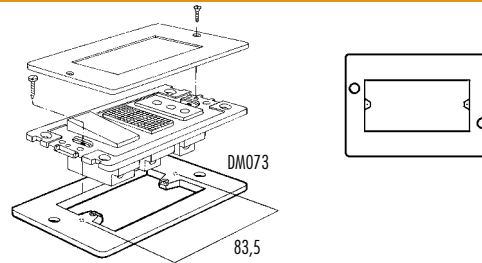

DM0736

Mostrina per il montaggio di apparecchiatura con interasse 55 e 60 mm.
Plate for fitting equipments with interaxis 55 and 60 mm.
120x85 mm

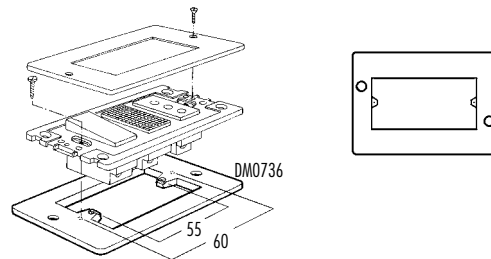

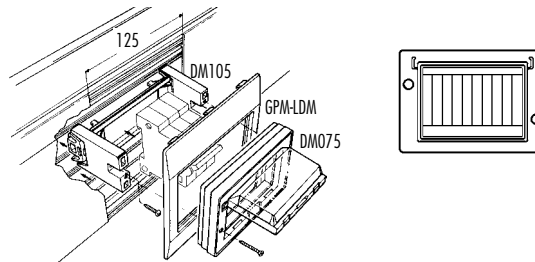

DM075

Mostrina per il montaggio in orizzontale di max 5 apparecchiature modulari (17,5) su guida DIN 46277/3. (Solo con DM105)
Plate for horizontal installation of max 5 modular equipment units (17,5) on DIN 46277/3 guide. (Only with DM105)
120x85 mm



DM082

Adattatore per connettori EDP. Si utilizza anche con porta mostrine LDM205 e GPM20.
IT sockets adaptor. Use with front plate holder LDM205 and GPM20 too.
120x85 mm

-  DM0821 Per connettori D-SUB (a vaschetta), 9-15-25 contatti
For D-SUB computer links (bowl), 9-15-25 pins.
-  DM0822 Per 2 connettori DIN
For 2 DIN computer links
-  DM0823 Senza fori
Without holes

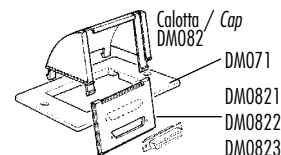

LDM per canali LINEADIN / for LINEADIN trunkings.

Placche porta mostrine per canali LINEADIN.
Per il montaggio delle mostrine DM071, DM072, DM073, DM075 (con distanziatore) e adattatori per connettori EDP DM082 su canali Lineadin 105-125-155-205xH50. Si incastrano a scatto sul canale.

Front plate panel point for LINEADIN trunkings.
For mounting of DM071, DM072, DM073, DM075, with spacer and lt. sockets adaptors DM082 on Lineadin 105-125-155-205xH50 trunkings. Click on the trunking.

