



**desk**

**3**

**Portautenze da scrivania.**  
*Writing-desk socket point.*



pagina / page

3.3.2

**Dati tecnici.**  
*Technical data.*



pagina / page

3.3.2

**CANALI SOTTOPAVIMENTO, TORRETTI E COLONNE PORTAUTENZE**  
**UNDERFLOOR TRUNKINGS, TURRETS AND SOCKET POINT COLUMNS**

**Portautenze da scrivania.**

Materiale: ABS Autoestinguente (UL94-VO).

**Writing-desk socket point.**

Material: Self-extinguishing ABS (UL94-VO).

**COLORI**  = Nero / Black  
**COLOURS** Type 9017

 **AL** = Alluminio  
Aluminium

**DESKOL**

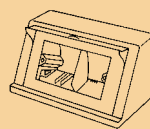

Portautenze da scrivania.  
Per apparecchiature con interasse 83,5/108 mm  
Writing-desk socket point.  
For equipments with interaxis 83,5/108 mm

Tipo	Colore	Imballo pz.
Part number	Colour	Packing pcs.

<b>DESKO</b>	 - AL	6
--------------	--	---

**DSK5**

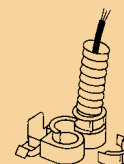

Adattatore. Per tubi flessibili Ø 25 mm  
Adaptor. For flexible ducts Ø 25 mm  
Colore/Colour: Nero/Black

Tipo	Colore	Imballo pz.
Part number	Colour	Packing pcs.

<b>DSK5</b>		12
-------------	---	----

## Dati tecnici / Technical data

### DESKO

**Portautenze da scrivania.**

**Writing-desk socket point.**

Dimensioni/Dimensions: 195x95x110 mm

Desko è fornito di una parete mobile che evita promiscuità delle linee elettriche con quelle telefoniche, inoltre, accoglie le più comuni utenze mod. 504 in commercio.

**Installazione con ingresso dei cavi dal fondo.**

Fratturare nei punti presegnati la base e fissarla, con viti o nastro biadesivo, al piano in corrispondenza del punto di uscita dei cavi sulla scrivania. Montare gli altri componenti come indicato in Fig. 1. Per il passaggio dei cavi tra due o più Desko affiancati, è sufficiente fratturare le pareti a contatto.

*Desko has an inner wall that avoids contact of electrical cables with the telephone ones.*

*Desko accepts the most common utilities Mod. 504 on the market.*

**Installation of Desko with cable entry from the base.**

Break the base in the marked points and fix it, with screws or double adhesive tape, to the plane connected with the exit point of the cables on the writing desk.

Mount the other parts as indicated in Fig. 1. For the passage of cables through two or more Desko, it's sufficient to break the contact walls.

Fig. 2

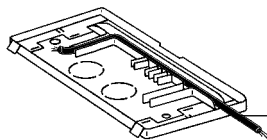
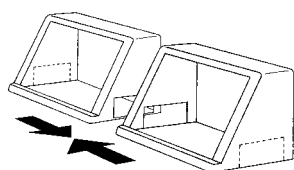

Guida preferenziale per linea telefonica.  
Preferential guide for telephone line.

Fig. 1

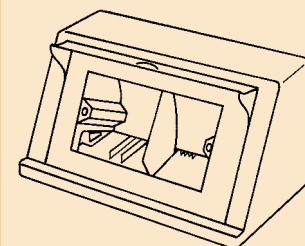
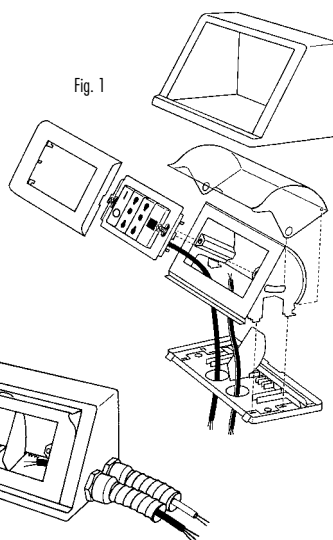

### DSK5

**Adattatore per tubi flessibili Ø 25 mm**

**Adaptor for hoses Ø 25 mm**

**Installazione con ingresso laterale dei cavi e guaine flessibili.**

Fissare la base con viti o nastro biadesivo, procedere al montaggio, servendosi degli appositi accessori, come indicato in Fig. 2

(accessorio in commercio) e Fig. 3 (nostro accessorio DSK5).

**Installation of Desko with lateral entry of cables and hoses.**

Fix the base with screws or double adhesive tape and then go on with the mounting by using the proper accessories as indicated in Fig. 2 (accessory on the market) and Fig. 3 (DSK5 our accessory).

Fig. 3

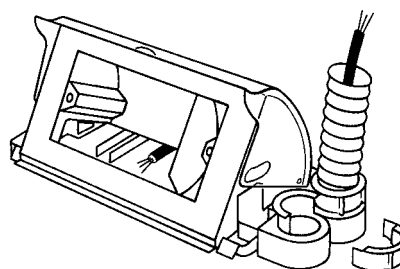

DSK5