

Minicanali per installare, ampliare o modificare impianti elettrici dove lo spazio è limitato.

Materiale: PVC Rigido Autoestinguente Classe 1 (UL94-V0).

Lunghezza: 2 metri

Colore: Bianco tipo 9010

I canali vengono forniti completi di coperchio.

Il sistema MiniTris è perfettamente integrabile con gli altri sistemi Tris2000 e Simmetris

Unitamente ai canali MTR3017BE e MTR4017BE viene fornito un traversino rispettivamente MTRAV30 e MTRAV40 ogni metro.

Fornibile a richiesta per quantità da concordare anche in altri colori

Minitrunkings for installation or modification of electrical systems where space is limited.

Self-extinguishing rigid PVC Class 1 (UL94-V0).

Length: 2 meters

Colour: White type 9010

All trunkings come complete with cover.

The MiniTris system is perfectly integrable with Tris2000 and Simmetris systems.

MTRAV30 and MTRAV40 will be included in the box of MTR3017BE and MTR4017BE.

Supplied upon request and for quantities to be agreed also in other colours.

CARATTERISTICHE TECNICHE DEL SISTEMA:

- Smontabile con attrezzo
- Grado di protezione: IP40
- Resistenza all'urto: 2J
- Temperatura d'uso: -5° / +60°C
- Temperatura trasporto ed immagazzinamento: -15° / +60°C

TECHNICAL FEATURES OF THE SYSTEM:

- Dismountable by a tool
- Protection degree: IP40
- Crash resistance: 2J
- Working temperature: -5° / +60°C
- Transport and stocking temperature: -15° / +60°C



Sezione fondo Section of the bottom	Codice Code	Dimensioni B x H mm Duct Size B x H mm	Imballo m Standard Carton m	S.G. mm ² G.S. mm ²	Lung. barre m Length m	Cartone peso Kg Carton Weight Kg
--	----------------	---	--------------------------------	--	---------------------------	-------------------------------------

	MTR2017BE	20x17x1	112 (7x16)	230	2	14,4
	MTR3017BE	30x17x2	80 (5x16)	300 (150x2)	2	16,5
	MTR4017BE	40x17x2	80 (5x16)	400 (200x2)	2	19,3



POLIPack MiniTris:

I minicanali vengono confezionati in un involucro di plastica per proteggerli dallo sporco causato dalla polvere di cantiere. Il minicanale risulterà così pulito ed integro fino al momento della sua installazione.

POLIPack MiniTris:

The minitrunkings are packaged in a plastic envelope to protect them from dirt and building site dust. The minitrunking will therefore be clean and complete until installation.



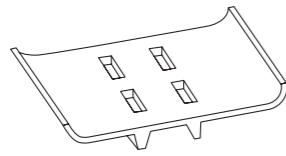

Traversino ferma cavi.
Cross-Arm.
2 x barra compresi nell'imballo del canale.
Including cable holding cross arms
(2 per length)

Codice Code	BxH mm BxH mm
----------------	------------------

MTR2017BE	20x17
MTR3017BE	30x17
MTR4017BE	40x17

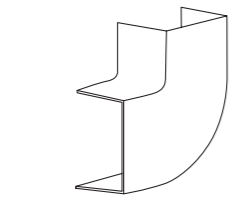

Angolo piano.
90° degree deviation.

Codice Code	BxH mm BxH mm
----------------	------------------

MTR2017BE	20x17
MTR3017BE	30x17
MTR4017BE	40x17

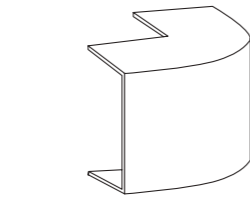

Angolo esterno fisso.
Outer bend.

Codice Code	Imballo pz. Packing pcs.
----------------	-----------------------------

MTR21AEBE	40 (4X10)
MTR31AEBE	40 (4X10)
MTR41AEBE	40 (4X10)

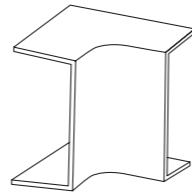

Angolo interno fisso.
Inner bend.

Codice Code	Imballo pz. Packing pcs.
----------------	-----------------------------

MTR21AIBE	40 (4X10)
MTR31AIBE	40 (4X10)
MTR41AIBE	40 (4X10)

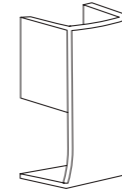

Raccordo a T.
T-joint.

Codice Code	Imballo pz. Packing pcs.
----------------	-----------------------------

MTR21TBE	40 (4X10)
----------	-----------

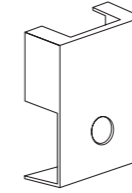

Raccordo a T.
T-joint.

Codice Code	Imballo pz. Packing pcs.
----------------	-----------------------------

MTR34TBE	40
MTR34TBE	40

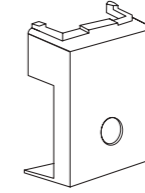

Raccordo scatola MTR44SU.
MTR44SU box junction.

Codice Code	Imballo pz. Packing pcs.
----------------	-----------------------------

MTR34SUBE	40
MTR34SUBE	40

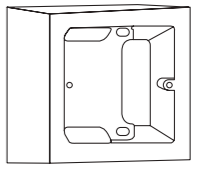

Scatola utenze interasse 80.
Socket box with centers of 80.

Codice Code	Imballo pz. Packing pcs.
----------------	-----------------------------

MTR44SUBE	10
MTR44SUBE	10

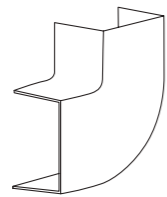

Angolo piano.
90° degree deviation.

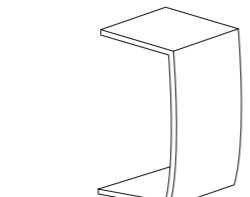

Giunto coperchio.
Cover joint.

Codice Code	Imballo pz. Packing pcs.
----------------	-----------------------------

MTR21APBE	40 (4X10)
MTR31APBE	40 (4X10)
MTR41APBE	40 (4X10)

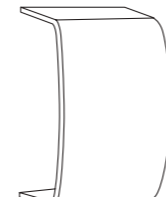

Tappo terminale.
End cap.

Codice Code	Imballo pz. Packing pcs.
----------------	-----------------------------

MTR21SBE	40 (4X10)
MTR31SBE	40 (4X10)
MTR41SBE	40 (4X10)

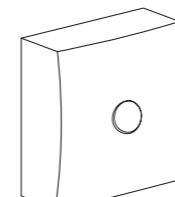

Scatola derivazione 55x55mm
Junction box 55x55mm

Codice Code	Imballo pz. Packing pcs.
----------------	-----------------------------

MTR55SDBE	9
MTR55SDBE	9
MTR55SDBE	9

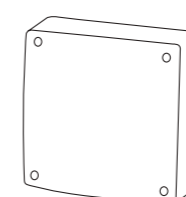

Scatola di derivazione per minicanali.
Junction box for minitrunking.

Codice Code	Imballo pz. Packing pcs.
----------------	-----------------------------

SCM090BEU	10
SCM090BEU	10
SCM090BEU	10

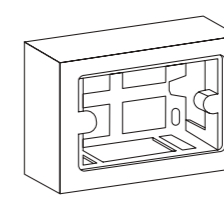

Scatola portautenze con interasse 83,5
(3 MOD.). Pareti prefabbricate per l'ingresso
dei minicanali.
Socket box for switches with centres
of 83,5 (3 MOD.). Prefracted walls for
minitrunkings entry.
GWT 850°C

Codice Code	Imballo pz. Packing pcs.
----------------	-----------------------------

SC503BE	9
SC503BE	9
SC503BE	9

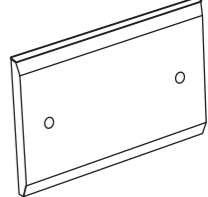

Coperchio cieco per scatola porta utenze
SC503.
Blind cover for box port users SC503

Codice Code	Imballo pz. Packing pcs.
----------------	-----------------------------

OL30102	80
OL30102	80
OL30102	80



Centralino a 7 moduli.
Switchboard at 7 modules.

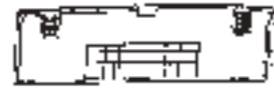

Raccordo tra centralino TRS16 e minicanali.
Junction between TRS16 switchboard with minitrunking.

Codice Code	BxH mm BxH mm
MTR2017BE	20x17
MTR3017BE	30x17
MTR4017BE	40x17

Codice Code	Imballo pz. Packing pcs.
TRS16BE	3
TRS16BE	3
TRS16BE	3

Codice Code	Imballo pz. Packing pcs.
TRS15MNBE	20
TRS15MNBE	20
TRS15MNBE	20

CONTENENZA CAVI WIRE FILL

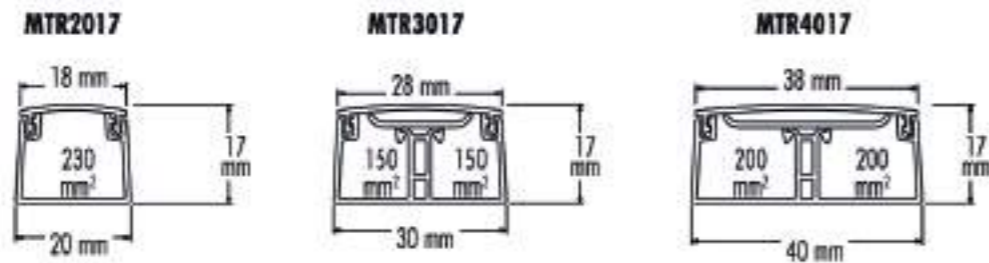

Sezione utile e capacità di contenenza cavi H07V - U/R/K
Wire fill capacity H07V - U/R/K

Codice Code	Sezione mm ² Section mm ²	n° conduttori / conductors				Ø Max mm ² cavo / cable
		1,5	2,5	4	6	
MTR2017	230	13	10	7	6	12
MTR3017	300 (150x2)	9	7	5	3	12
		9	7	5	3	12
MTR4017	400 (200x2)	11	9	6	4	12
		11	9	6	4	12

MTRAV

Traversino ferma cavi per canale
MTR3017 e MTR4017.
Cross arm for MTR3017 and MTR4017
trunking.

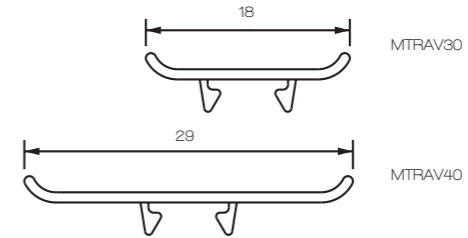

MTRAE

Angolo esterno fisso.
Outer bend.

Codice Code	Dimensioni / Dimensions mm			
	A	B	C	D
MTR21AEBE	35	35	18	23
MTR31AEBE	35	35	18	33
MTR41AEBE	35	35	18	43

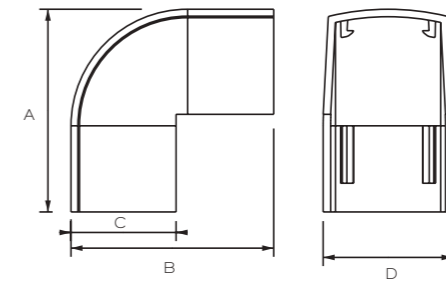

MTRAI

Angolo interno fisso.
Inner bend.

Codice Code	Dimensioni / Dimensions mm			
	A	B	C	D
MTR21AIBE	36	36	18	23
MTR31AIBE	36	36	18	33
MTR41AIBE	36	36	18	43

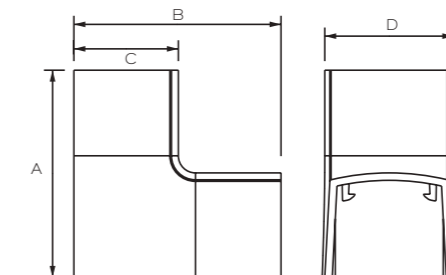

MTRAP

Angolo piano.
90° degree deviation.

Codice Code	Dimensioni / Dimensions mm			
	A	B	C	D
MTR21APBE	41	41	18	23
MTR31APBE	51	51	18	33
MTR41APBE	61	61	18	43

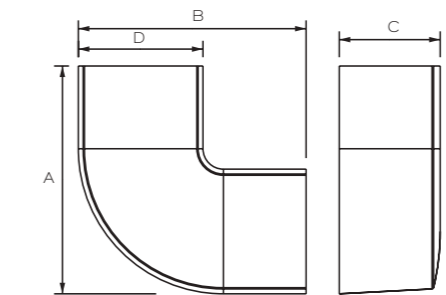

□ BEU/BE - Bianco / White Type 9010

MTRG

Giunto coperchio.
Cover joint.

Codice Code	Dimensioni / Dimensions mm		
	A	B	D
MTR21GBE	20	18	23
MTR31GBE	20	18	33
MTR41GBE	20	18	43

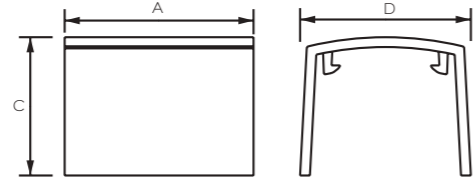

MTR44SU / MTR34SU

MTR44SU
Scatola utenze interasse 60.
Socket box with centers of 60.

MTR34SU
Raccordo scatola MTR44SU.
MTR44SU box junction.

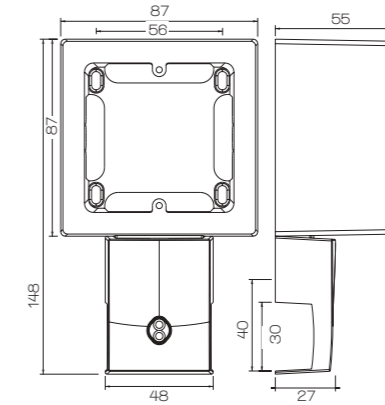

MTRS

Tappo termale.
End cap.

Codice Code	Dimensioni / Dimensions mm		
	A	B	D
MTR21SBE	17	18	23
MTR31SBE	18	18	33
MTR41SBE	18	18	43

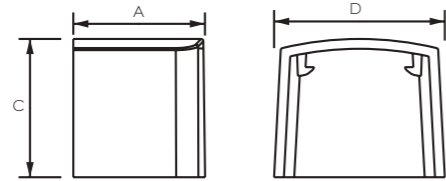

MTR55SD

Scatola di derivazione.
Junction box.
55x55 mm

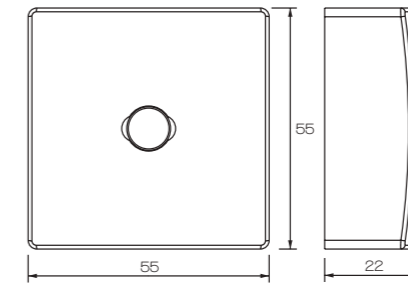

MTR21T

Raccordo a T per canale MTR2017.
T-joint for MTR2017 trunking.

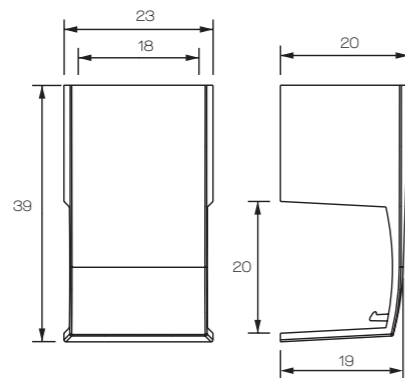

SCM090

Scatola di derivazione.
Junction box.
90x90 mm

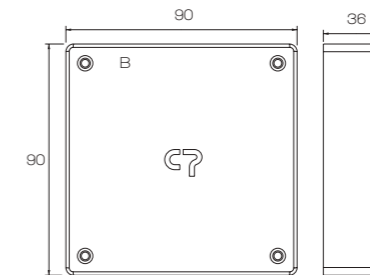
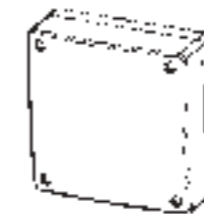

MTR34T

Raccordo a T.
T-joint.

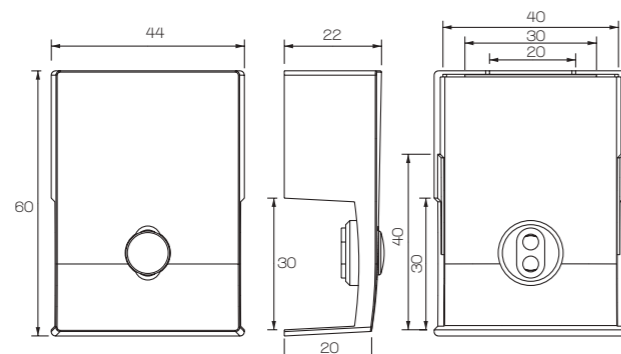

SC503

Scatola portautenze con interasse 83,5 (3 MOD).
Pareti prefabbricate per l'ingresso dei minicanali.
Socket box for switches with centres of 83,5 (3 MOD).
Prefabricated walls for minitrunkings entry.
GWT 850°C

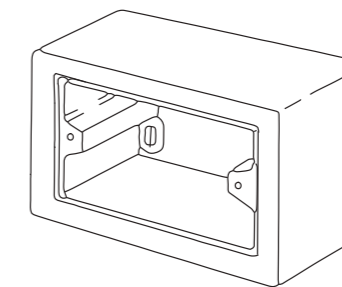

MINITRIS: COMPATIBILE CON TRIS2000 E SIMMETRIS 2120

La perfetta compatibilità fra Minitris, Tris 2000 e Simmetris 2120 rende possibile, facile ed esteticamente gradevole la canalizzazione di tutte le utenze, senza rinunciare alla sicurezza assoluta e alla comodità di avere un'unica scatola portautenze. Gli accessori in comune fra i tre sistemi, inoltre, permettono di realizzare impianti veramente completi, in grado di soddisfare le diverse esigenze.

Il risultato è un sistema versatile che garantisce il massimo in termini di praticità, semplicità di installazione ed eleganza.

The perfect compatibility between Minitris, Tris 2000 and Simmetris 2120 make the ordering of your utilities an easy and good-looking job, in total safety and comfort thanks to a single cable-holding box. The accessories shared by the three systems also help installing really complete systems capable of meeting different needs. The end result is a versatile system which guarantees ultimate practicality, user-friendliness and elegance.

